

TIMBER
SASH
WINDOWS

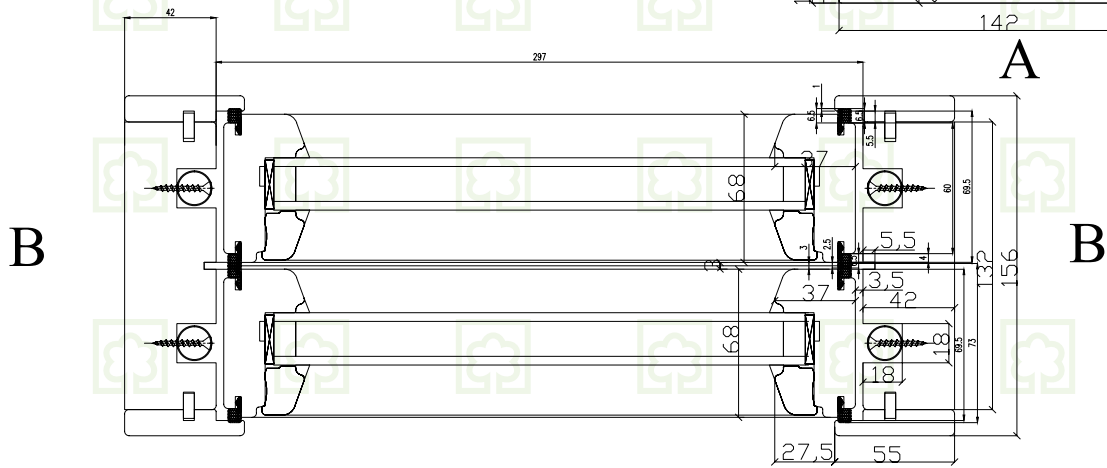

SASH WINDOW

DOUBLE SLIDING SASH

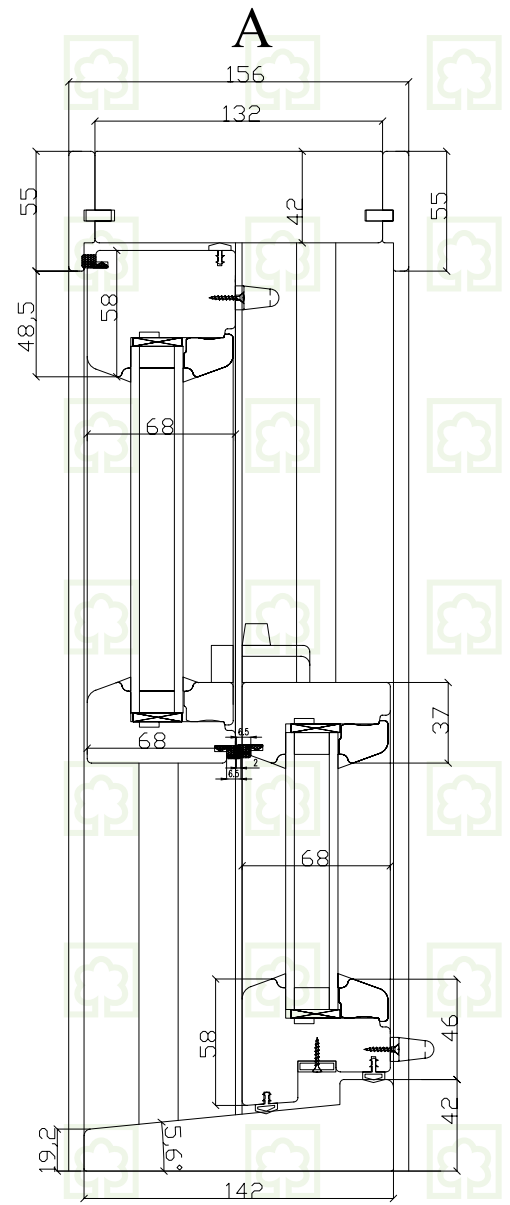
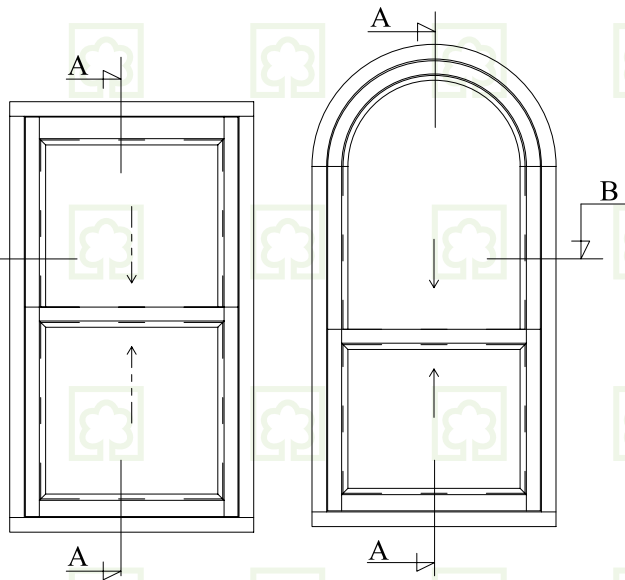

SASH WINDOW

TILT AND SLIDE

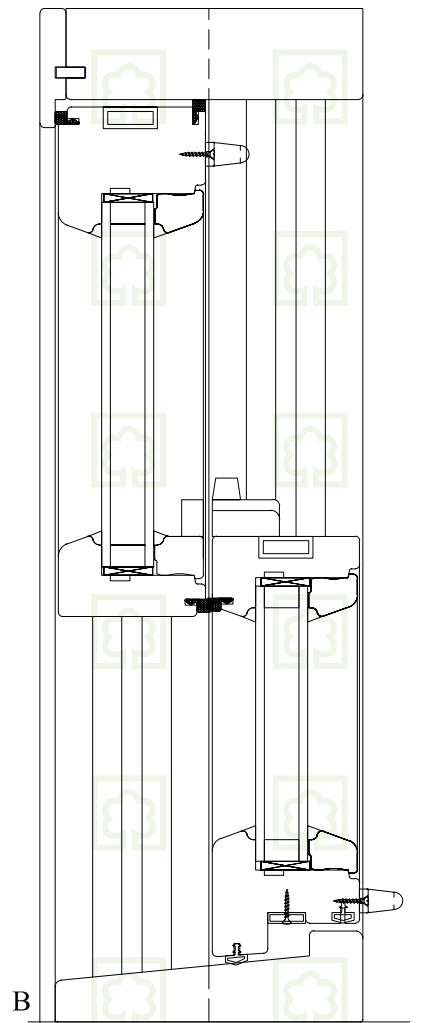
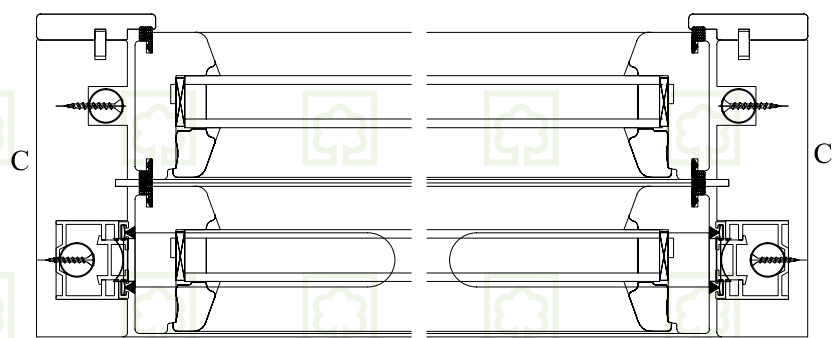
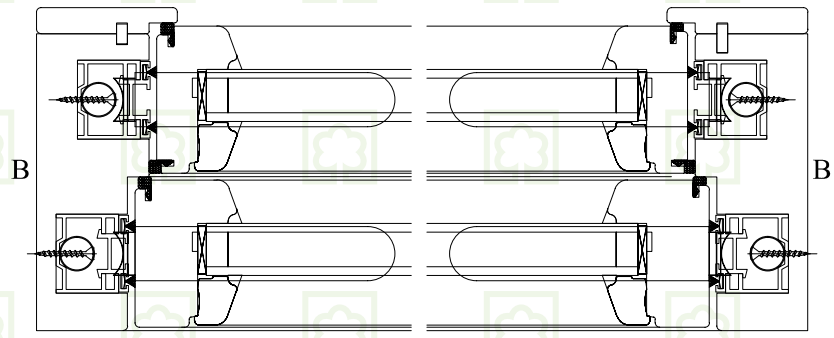
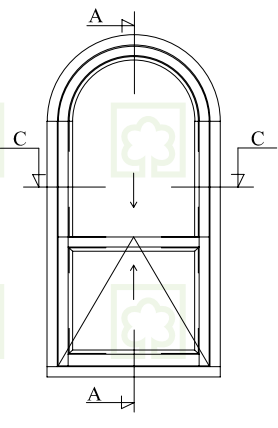
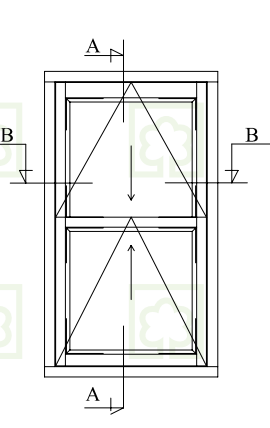

A

A

SASH WINDOWS



MATERIALS:

Wood:

We use laminated scantlings certified FSC or PEFC of

- SCOTTS PINE laminated in 3 finger jointed layers,
- MERANTI or WHITE OAK laminated in 2 solid layers and 1 intermediate finger jointed layer.

All our wood components are treated against insects, fungi and humidity, then stained or painted according to your choice with water based products.

- Stain colours will be selected from our colour chart.
- Any RAL colour may be selected for paints.

Balances:

Balances:

High technology mechanisms combining stainless steel rod torsions and tension springs are used in keeping the balance of sashes at any point of its movement.

We also produce timber box sash windows. These are traditional vertical sliders working with weights and cords.

Seals:

- The seals between glazing and profiles are of SILICON.
- The seals are of Q-LON (SCHLEGEL).

IRONMONGERY:

Bow Handles



Cam Lock and Keeps



Finger Pulls





ELEGANT LINES

We offer the below options of profiles for use in windows to satisfy different tastes.

EXTERIOR GLAZING BARS AND BEADS

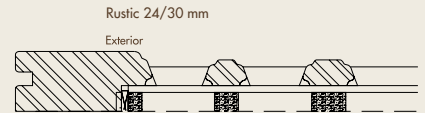
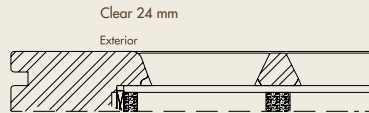
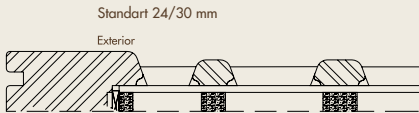

INTERIOR GLAZING BARS AND BEADS

